



Design and Analysis of a Candlenut Shell Breaking Machine

Zulhendri¹, Yuliarman², Elvis Adril³, Yudha Contrian Pratama⁴.

^{1,2,3,4}Departement Mechanical Engineering, Politeknik Negeri Padang,
Jl. Kampus, Limau Manis, Kec. Pauh, Kota Padang, Sumatera Barat, 25164, INDONESIA

Corresponding Zulhendri, zulhendri@pnp.ac.id

Received 30 April 2024; Accepted 26 June 2024; Available online 30 June 2024

Abstract

Candlenut seeds are one of the plants that grow in Indonesia. Candlenut leaves and seeds have many benefits that are useful for human life. Candlenut oil can be used as a raw material for making varnish, paint, soap, fabric oil, resin, synthetic leather, lubricants, compost, and cleaning or polishing mixtures. Candlenut fruit has a shape ranging from oval to round, green to brownish green, with a length of $\pm 5-6$ cm and a width of $\pm 5-7$ cm. One candlenut contains one to three candlenut seeds. To get the candlenut seeds, they must be removed from their hard and thick shell by breaking them. So far, getting candlenut seeds has been done by breaking them manually by hitting them one by one. This is certainly not effective and takes a long time. Based on this, a tool was designed and made for breaking candlenut shells using a 2 HP motor drive. This candlenut shell breaker tool consists of a throwing part that rotates vertically, which, due to the centripetal effect, throws the candlenut kernels against the wall of the breaker. The broken candlenut kernels and shells fall down into the filter section to separate the kernels and shells, then the candlenut kernels go inside holding containers. To get the ideal launcher rotation, several speed variations were tested, namely: 1. 250 rpm, 2. 350 rpm, and 3. 500 rpm. Of the three variations of rotation, the best rotation was obtained with the shell breaking and the seeds releasing well without breaking, namely at 350 rpm.

Keywords: Cracker, hazelnut, shell, thrower

1. INTRODUCTION

Candlenut seeds are one of the crops that grow in Indonesia and have broad economic value and benefits. Candlenut leaves and seeds have many benefits that are useful for human life [1]. Candlenut oil can be used as a raw material for making varnish, paint, soap, fabric oil, resin, synthetic leather, lubricants, compost, and cleaning or polishing mixtures. Candlenut fruit has a shape ranging from oval to round, green to brownish green in color, with a length of around 5–6 cm and a width of around 5–7 cm [2]. One candlenut contains one to three candlenut seeds, which must be released from the hard and thick shell by breaking them.

Candlenut farmers generally still carry out the process of breaking the shells of candlenuts manually by hitting them [3]. This traditional method requires a long time and a lot of energy, so it is less effective and efficient at increasing productivity. Apart from that, this manual process also increases the risk of damage to candlenut seeds, which in turn can reduce the economic value of the harvest. In the midst of increasingly tight market competition, time and energy efficiency have become very important factors in agricultural activities, especially for crops with high economic value, such as candlenuts.

The tropical climate in Indonesia, which allows candlenuts to grow abundantly throughout the year, provides great potential for candlenut farming [4]. However, this potential has not been exploited optimally due to limitations in post-harvest processing techniques. Therefore, a more effective and efficient solution is needed to overcome this problem. It is hoped that the development of candlenut shell-breaking machine technology that

is capable of working quickly and with minimal damage to the seeds can be a practical solution for farmers. With a specially designed machine, the shell-breaking process can be faster, more efficient, and safer, thereby increasing the productivity and welfare of candlenut farmers in Indonesia. This research aims to design and analyze a candlenut shell-breaking machine that is expected to increase farmer productivity and efficiency. candlenut. By using machines, the shell-breaking process is expected to be faster, more efficient, and safer than manual methods. This machine is also expected to reduce damage to candlenut seeds so that the quality and quantity of production can be increased. The design of this machine will consider technical and economic factors to ensure that it can be operated easily and affordably for farmers [5].

Specifically, this research will include the design stages of the shell-breaking machine mechanism, selecting appropriate materials and components, as well as testing machine performance. An analysis will be carried out to assess the effectiveness of the machine in terms of breaking speed, rate of seed damage, and energy efficiency. It is hoped that the results of this research can provide practical and applicable solutions for candlenut farmers, as well as contribute to increasing their productivity and welfare.

2. RESEARCH METHODS

This research aims to design and analyze a candlenut shell breaking machine. The research method used includes several stages, namely: literature study, concept design, material and component selection, prototyping, testing, and data analysis. The following are the research steps detailed in the form of schemes and descriptions which can be seen in **Fig.1**:

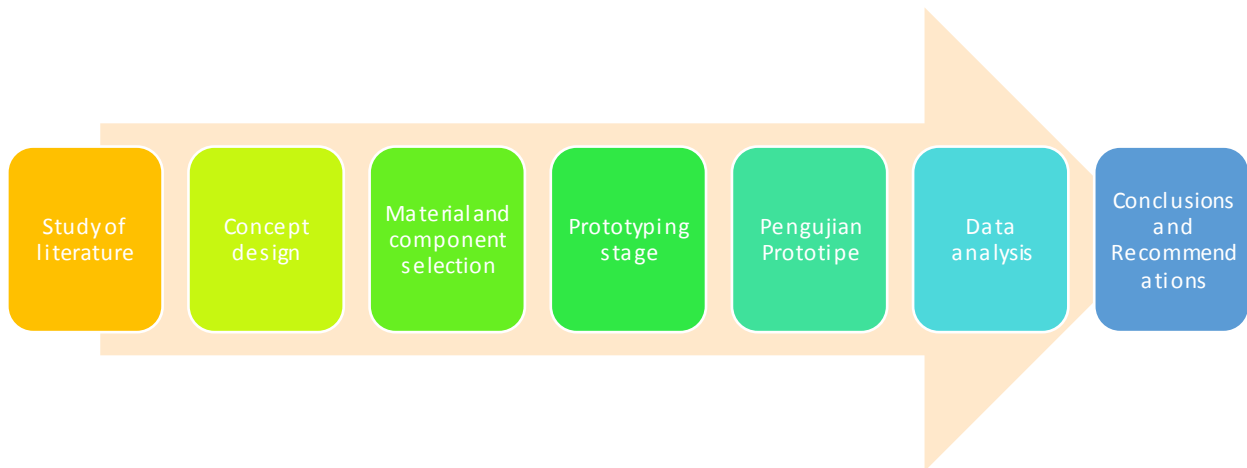

Fig. 1. Research Methods

1. **Study of literature**
The aim of this literature study is to collect information about existing technology, farmers' needs, and the physical properties of candlenut fruit and seeds. Activities carried out include reviewing journals, books and publications related to nut crushing machines and agricultural technology, as well as understanding the properties of candlenut shell materials and existing crushing methods. The results of this literature study will provide the theoretical basis and concepts that will be used in designing a candlenut shell breaking machine.
2. **The concept design stage** is to create several initial machine designs based on the results of literature studies. Activities carried out include making sketches and diagrams of breaking mechanisms, considering various mechanisms such as beaters, crushers, or pressure, and choosing the best design concept based on ease of manufacture, cost, and efficiency. The result of this stage is a machine concept design that will be developed further.
3. **The material and component selection stage** is to determine the right materials and components for making a prototype. Activities carried out include determining strong and durable material specifications for machines, selecting mechanical components such as motors, gears and bearings, as well as calculating the cost and availability of materials. The result of this stage is a list of materials and components that will be used to make a prototype of a candlenut shell breaking machine.
4. **The prototyping stage** is to turn the concept design into a real prototype. Activities carried out include drawing technical details and preparing tools and materials, cutting, welding and assembling components, as well as assembling all machine parts according to the design. The result of this stage is a prototype of a candlenut shell breaking machine.

5. The data analysis stage is analyzing test result data to evaluate engine performance. Activities carried out include comparing test results with established targets and standards, identifying design weaknesses and strengths, and calculating statistics such as average breaking time, rate of seed damage, and energy efficiency. The result of this stage is a machine performance analysis report along with recommendations for improvements. For the analysis of this tap, several equations are used that support the calculation of machine components. candle nut shell breaking machine with the following equations:

a. Centripetal force.

Centripetal force is the force that makes objects move in a circle [6] can be seen **Fig. 2**.

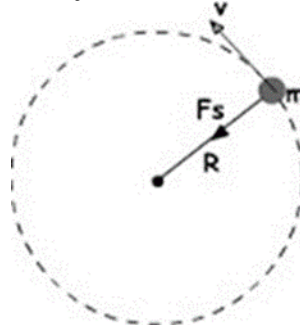

Fig. 2. Centripetal Force

This equation can be used to calculate the Centripetal Force on machine components, which can be seen in equations 1 and 2.

$$F_s = m \cdot a_s \tag{1}$$

$$F_s = m \frac{v^2}{R} = m\omega^2 R \tag{2}$$

This equation describes the relationship between an object's mass (m), centripetal acceleration (a_s), tangential velocity (v), radius of a circular path (R), and angular velocity (ω). The mass of an object (m) is the size of the object in kilograms (kg), centripetal acceleration (a_s) is the acceleration towards the center of a circular path in units of meters per second squared (m/s^2). Tangential speed (v) is the speed of an object at a certain point on a circular path in meters per second (m/s). The radius of a circular path (R) is the distance from the center of the circular path to a certain point on the path in meters (m). The angular velocity (ω) is the angular speed of the object in radians per second (rad/s). This equation is used to calculate the interactions between mass, acceleration, linear velocity, radius, and angular velocity in the context of circular motion.

b. Calculations determine the breaking plate wall material can be calculated using equation 3 [7].

$$\sigma = \frac{F}{A} \tag{3}$$

The equation provided relates to the calculation of compressive stress (σ), where F represents the centripetal force exerted by the candlenut seeds in Newtons (N), and A is the cross-sectional area of the seeds in square meters (m^2). According to the calculation, the pressure exerted by the candlenut seeds on the crushing wall amounts to 0.4 MPa. This level of stress does not pose a risk of damaging the wall, as it is constructed from st.37 steel, which can withstand a maximum compressive stress of 370 MPa.

c. Belt and Pulley Planning

1) Comparison of Pulley Rotation

The pulley rotation ratio can be calculated with the equation [7]:

$$\frac{n_1}{n_2} = \frac{d_p}{d_p} = i \tag{4}$$

2) Diameter of driving pulley (d_p) and driven pulley (d_p)

$$i = \frac{D_p}{d_p} \tag{5}$$

Based on the calculations above, a pulley diameter of 203 mm is taken according to market standards. So the diameter of the driving pulley (d_p) = 76.2 mm and the diameter of the driven pulley (D_p) = 203 mm.

3) Belt Type Selection

Most belt transmissions use V belts because they are easy to handle and cheap.

4) Belt Linear Speed (v)

The magnitude of the circumferential speed or linear speed of the belt can be expressed by the equation:

$$v = \frac{\pi \cdot dp \cdot n1}{60 \cdot 1000} \quad (6)$$

5) Belt Circumference Length (L)

The length of the belt circumference can be calculated using the equation [8]:

$$L = 2C + \frac{\pi}{2}(dp + Dp) + \frac{1}{4c}(Dp - dp)^2 \quad (7)$$

6) Correction of Axis Distance (C)

The axle distance according to the standard belt length can be calculated using the equation:

$$C = \frac{b + \sqrt{b^2 - 8(Dp - dp)^2}}{8} \quad (8)$$

$$b = 2L - 3.14(Dp + dp) \quad (9)$$

g. Contact Angle (θ)

The contact angle can be calculated by the formula:

$$\theta = 180^\circ - \frac{57(Dp - dp)}{c} \quad (10)$$

7) Style on the Belt

The force that occurs on the belt is calculated using the equation

$$F = \frac{T}{rp} \quad (11)$$

6. The conclusion and recommendation stage is to summarize the research results and provide recommendations for further development. Activities carried out include drawing up conclusions based on data analysis, providing suggestions for improving the design and solution process, and preparing a final research report. The result of this stage is the final conclusion regarding the success of the design and analysis of the machine as well as recommendations for implementation in the field.

With this structured research method, it is hoped that the research can produce an effective and efficient candlenut shell breaking machine, which can increase the productivity and welfare of candlenut farmers.

3. DISCUSSION AND RESULTS

The analysis results show that the candlenut shell breaking machine designed and tested in this research is very helpful to farmers. With this machine, shell breaking is faster, more efficient and safer, thereby saving time and energy compared to manual methods. In analyzing this machine, it is necessary to design design drawings and calculate the test results of the candlenut shell breaking machine.

- a. Design drawing and calculating the test results of the candlenut shell crushing machine.

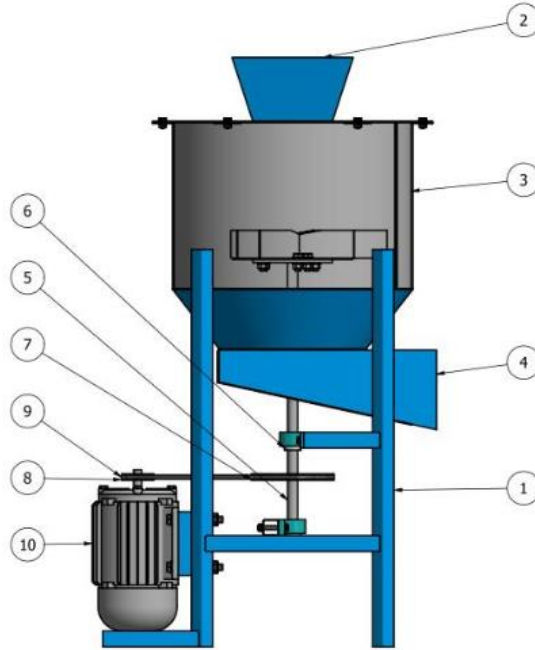

Fig. 3. The design of the candlenut shell breaking tool

Information:

1. Frame
2. Incoming funnel
3. Tube/wall breaker
4. Funnel out
5. Ejection shaft
6. Bearings
7. Throwing pulley
8. V-belt
9. Motor/drive pulley
10. Motorcycle

This research aims to design and analyze a candlenut shell breaking machine to increase the productivity and efficiency of candlenut farmers. This machine is designed to speed up the process of breaking candlenut shells, reduce the physical burden on farmers, and minimize damage to candlenut seeds so that the economic value of the harvest can be increased. With a focus on safety, comfort and ease of operation, this machine is expected to be easy for farmers to operate and affordable for widespread use. In addition, this machine is designed to be energy efficient while still providing optimal performance, and uses strong and durable materials and components to ensure long-term reliability and sustainability. It is hoped that the results of this research will provide significant practical solutions for candlenut farmers, contributing to increasing productivity and farmer welfare.

- b. Component analysis

The design and construction of a candlenut shell crushing machine requires careful calculation of various main components. This includes calculating the force on the candlenut seed thrower to ensure the seeds are thrown with the right force as well as calculating the compressive force required to crack the shell without damaging the seeds. In addition, belt and pulley planning must be done carefully to ensure efficient and reliable power transfer between the motor and breaker components. The planning of the pegs on the ejector shaft also needs to be considered so that the component can function stably and safely. This calculation is very important to ensure the machine works optimally, efficiently and safely for the user.

Determining the style of the candlenut seed thrower

1. Centripetal force.

Centripetal force is the force that causes an object to move in a circle. In this context, for a thrower rotation (n) of 540 rpm and a trajectory radius (R) of 240 mm or 0.24 m, centripetal force plays an important role in keeping the object in its circular path.

Obtained centripetal force:

$$F_s = m\omega^2R$$

$$F_s = m \left(\frac{2\pi n}{60} \right)^2 R$$

$$= 9,26 \text{gr} \left(\frac{2\pi 540 \text{rpm}}{60} \right)^2 0,24 \text{ m}$$

$$F_s = 125.6 \text{ N}$$

As part of this research, compression tests were carried out on 10 candlenut kernels to evaluate the strength and durability of their shells. The results of the pressure test are as follows **Table 1:**

Table 1. Test data for compressive force and mass

No	Sample	Yield (kN)	Mass (g)
1	Candlenut 1	1.5	10
2	Candlenut 2	1.5	10.2
3	Candlenut 3	1.5	10
4	Candlenut 4	1.5	10.2
5	Candlenut 5	1.5	9.9
6	Candlenut 6	1.5	10.6
7	Candlenut 7	1.5	10
8	Candlenut 8	1.5	10
9	Candlenut 9	1.5	10.1
10	Candlenut 10	1.5	10.2

Based on the results of the research that has been carried out, several important things can be concluded regarding the strength and physical characteristics of candlenut seeds. The test results show that the compressive force value of one candlenut seed is 1.5 kN, and the average value of the mass of candlenut kernels is 10 grams. These findings provide significant information regarding the mechanical strength of candlenut kernels, which can be used as a reference in designing more efficient and effective candlenut shell breaking machines can be seen in **Table 2.**

Table 2. Component calculation resultscandlenut shell breaking machine

No	Description	Results
1	Calculations determine the ST 37 iron plate wall material	max pressure of 370 Mpa.
2	drive pulley diameter	(dp) = 76.2 mm
3	diameter of the driven pulley	(Dp) = 203 mm

2. Pulley planning

In this research, pulley planning is an important part of the design of a candlenut shell breaking machine. The belt used is a type A V-belt, which was chosen to ensure efficiency and stability in power transmission [9]. The dimensions of the pulley used can be seen in **Fig. 4** below.

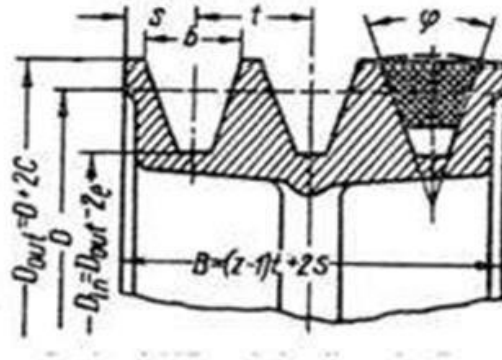

Fig.4. Pulley dimensions

3. Drive pulley dimensions

a) Drive pulley diameter (dp)

Based on the planning, the diameter of the drive pulley is 76.2 mm

b) Pulley outer diameter (Dout)

The outer diameter of the pulley is calculated by the formula:

$$D_{out} = d_p + 2c$$

$$D_{out} = 76.2 \text{ mm} + (2 \times 3.5 \text{ mm})$$

$$D_{out} = 83.2 \text{ mm}$$

c) Pulley inner diameter (Din)

The inner diameter of the pulley is calculated by the formula:

$$D_{in} = D_{out} - 2e$$

$$D_{in} = 83.2 \text{ mm} - (2 \times 12.5 \text{ mm})$$

$$D_{in} = 56.4 \text{ mm}$$

d) Pulley width (b)

The pulley width is calculated by the formula:

$$b = (z - 1)t + 2s$$

$$b = (1 - 1)16 + (2 \times 10)$$

$$b = 20 \text{ mm}$$

4. Dimensions of driven pulley [7]

a) Diameter of driven pulley (dp)

Based on the planning, the diameter of the drive pulley is 203.2 mm

b) Pulley outer diameter (Dout)

The outer diameter of the pulley is calculated by the formula:

$$D_{out} = d_p + 2c$$

$$D_{out} = 203.2 \text{ mm} + (2 \times 3.5 \text{ mm})$$

$$D_{out} = 210.2 \text{ mm}$$

c) Pulley inner diameter (Din)

The inner diameter of the pulley is calculated by the formula:

$$D_{in} = D_{out} - 2e$$

$$D_{in} = 210.2 \text{ mm} - (2 \times 12.5 \text{ mm})$$

$$D_{in} = 185.2 \text{ mm}$$

d) Pulley width (b)

The pulley width is calculated by the formula:

$$b = (z - 1) t + 2s$$

$$b = (1 - 1) 16 + (2 \times 10)$$

$$b = 20\text{mm}$$

5. Planning the Stake on the Throwing Shaft

In this research, the planning of the pegs on the throwing shaft is a crucial aspect to ensure the stability and efficiency of the candlenut shell breaking machine. This initial stage of planning involves choosing the right stakes. The post selection process must consider various technical factors to ensure that the post can withstand operational loads and maintain the stability of the breaking mechanism. Below are further details regarding the selection of pegs used.

Ukuran nominal pasak $b \times h$	Ukuran standar $b_1, b_2,$ dan b_3	Ukuran standar h		C	l	Ukuran Standar l_1	Ukuran Standar l_2			r_1 dan r_2	Referensi Diameter poros yang dapat dipakai d^{**}
		Pasak prismatis Pasak lurus	Pasak Tirus				Pasak Prisma is	Pasak Luncur	Pasak Tirus		
2 x 2	2	2		0,16-	6-20	1,2	1,0			0,08-	Lebih dari 6-8
3 x 3	3	3		0,25	6-36	1,8	1,4			0,16	" 8-10
4 x 4	4	4			8-45	2,5	1,8				" 10-12
5 x 5	5	5			10-56	3,0	2,3				" 12-17
6 x 6	6	6			14-70	3,5	2,8				" 17-22
(7 x 7)	7	7	7,2	0,25-	16-80	4,0	3,01	3,5	3,0	0,16-	" 20-25
8 x 7	8	7		0,40	18-90	4,0	3,3			0,25	" 22-30
10 x 8	9	8			22-110	5,0	3,3				" 30-38
12 x 8	10	8			28-140	5,0	3,3				" 38-44
14 x 9	12	9			36-160	5,5	3,8				" 44-50
(15 x 10)	15	10	10,2	0,40-	40-180	5,0	5,0	5,5	5,0	0,25-	" 50-55
16 x 10	16	10		0,60	45-180	6,0	4,3			0,40	" 50-58
18 x 11	18	11			50-200	7,0	4,4				" 58-65
20 x 12	20	12			56-220	7,5	4,9				" 65-75
22 x 14	22	14			63-250	9,0	5,4				" 75-85
(24 x 16)	24	16	16,2	0,60-	70-280	8,0	8,0	8,5	8,0	0,40-	" 80-90
25 x 14	25	14		0,80	70-280	9,0	5,4			0,60	" 85-95
28 x 16	28	16			80-320	10,0	6,4				" 95-110
32 x 18	32	18			90-360	11,0	7,4				" 110-130

Fig. 5. Standard Size of Pegs [10]

The selection of pegs is based on reference from table 2 of the peg sizes corresponding to the shaft diameter, which in this case is 25 mm. Referring to the peg size table ensures that planning is done accurately, so that errors do not occur in selecting and installing pegs. This is important to ensure that the peg can withstand the load and force acting on the shaft, so that the machine components function properly and stably.

Designing the pegs on the ejector shaft requires precise specifications to ensure the stability and safety of machine operation. Based on a shaft diameter of 25 mm, the appropriate peg size is with a cross section of 7 x 7 mm. The depth of the keyway on the shaft (h_1) is planned to be 4.0 mm, while the depth of the keyway on the naf (h_2) is planned to be 3.0 mm. This calculation is carried out to ensure that the peg can withstand the force acting on the shaft, so that the machine components can function properly and efficiently.

6. Tangential force on the peg (F) [7].

Post Shear Stress

The post material used is ST 37 with a tensile stress $\sigma_t = 37 \text{ kg/mm}^2$, so the post shear stress

$$\tau_g = 0.8 \times \sigma_t$$

$$\tau_g = 0.8 \times 37 \text{ kg/mm}^2$$

$$\tau_g = 29.6 \text{ kg/mm}^2$$

Based on the design and calculations above, a candlenut shell breaking tool was made as can be seen in the following Fig.5.



Fig. 5. Assembly results of the candlenut shell breaking machine

This tool is driven by an electric motor with specifications can be seen in **Table 3**.

Table 3. Electric motor with specifications

Properties	Mark	Unit
Power	1.5	Kw
Motor Weight	38	Kg
Motor Rotation	1440	Rpm
Current voltage	220	V
Strong currents	13	A
Frequency	50	Hz

During the first test, the machine showed strong vibrations. After checking, it was found that the ejector rotor was unbalanced. Repairs were made to the ejector rotor, so that the engine could operate properly. Next, tests were carried out by varying the rotation speed of the ejector rotor at 250 rpm, 350 rpm and 500 rpm. This speed variation is regulated using a dimmer, the shape of which can be seen in **Fig. 6**. below.





Fig. 6. Dimmer device used [11]

The results of using the Dimmer tool obtained from trials on the candlenut shell breaking machine can be seen in **Tables 4 and 5**.

Table 4. Results Testing of tools on a candlenut shell breaking machine

No	Mg (kg)	Speed Control	Volt Meter	Results
1	5 kg	250	40 – 50 V	Doesn't break
2	5 kg	350	70 – 90 V	Broken good
3	5 kg	500	100-120 V	Shattered

Table 5. Image of test results for candlenut condition

		
Dimmer 250 speed regulator, with volts 40 – 50 V	Dimmer 350 speed regulator, with volts 70 – 90 V	Dimmer 500 speed regulator, with 100 – 120 volts
Test results 1	Test results 2	Test results 3

The test results in **Tables 4** and **Tables 5** show that the rotor rotation speed influences the effectiveness of cracking candlenut shells on the machine. At a speed of 250 rpm with a voltage of 40-50 volts, most shells do not break sufficiently. On the other hand, at a speed of 350 rpm with a voltage of 70-90 volts, most shells managed to break well. However, at a speed of 500 rpm with a voltage of 100-120 volts, most of the candlenut shells shattered. From the results of this experiment, a speed of 350 rpm showed the best performance in cracking candlenut shells with optimal results. These findings can serve as a basis for further adjustments in the design and use of pecan shell crushing machines to increase overall production efficiency and yield.

In this research, it was found that the rotation speed of the machine rotor had a significant effect on the effectiveness of cracking candlenut shells. The research results showed that at a speed of 350 rpm with a voltage of 70-90 volts, the machine achieved optimal cracking of candlenut shells, while speeds outside this range produced unsatisfactory results. These findings are in line with previous research which highlights the importance of parameters such as rotation speed in the design of effective and efficient candlenut shell crushing machines. For example, research by Agustina et al. [12] describes the development of a prototype of a candlenut shell crushing machine that produces adequate results by observing the correct rotor speed. Another study by Siregar et al. [13] emphasized that proper regulation of the rotor rotational speed can improve machine performance in shell breaking. Apart from that, research by Adriansyah & Setiawan [14] regarding the development of tools based on the impact concept also strengthens the importance of this factor in designing efficient machines. The research results of Hutapea & Tumanggor [15] and Anwar & Marbun [16] also indicate that variations in rotor speed affect machine efficiency in the process of cracking candlenut shells. Thus, this research makes an important contribution in increasing understanding of the factors that influence the performance of candlenut shell breaking machines, with a focus on optimizing rotor rotation speed.

1. CONCLUSION

Based on the data and analysis that has been carried out, it can be concluded that several important things are related to the design and research results of this candlenut shell breaking machine. Firstly, this tool was successfully developed using an electric motor with a power of 2 HP and an optimal speed configuration, namely the motor rotates at 1400 rpm with the use of a 76.2 mm driving pulley and a 203.2 mm driven pulley, and a throwing rotor speed of 525 rpm. . Second, this machine is able to break the shells of candlenut nuts effectively using a spinning roller that rotates in the body of the machine, with the result that the candlenut shells are broken and separated from the seeds when thrown between the ejector rollers towards the wall. Third, from various experiments, the optimal speed of the throwing rotor was proven to be 350 rpm, which resulted in cracking candlenut shells with good efficiency. Fourth, the integrated filter system in the exit funnel makes it easier to sort crushed candlenut seeds and shells as well as intact seeds. These findings confirm that this machine has the potential to increase yield and efficiency in the process of cracking candlenut shells, as well as facilitating further processing for candlenut farmers.

ACKNOWLEDGMENT

Sincere thanks are expressed to the Director of Padang State Polytechnic through DIPA P3M Padang State Polytechnic for the financial support that has made it possible to carry out this research well. Also to the Head of the Mechanical Engineering Department for the Machinery Workshop facilities provided as a place to make this candlenut shell breaking tool. Don't forget the fellow lecturers and PLP who have provided assistance and support so that this research can be carried out smoothly and as expected.

REFERENCES

- [1] Direktorat Jendral Perkebunan. (2008). Budidaya Kemiri. Kementrian Pertanian. Jatmiko, W. (2008). Perawatan Pohon Kemiri.
- [2] Ulung, G., & Studi, P. (2014). *Sehat alami dengan herbal: 250 tanaman berkhasiat obat* (Vol. 1). Gramedia Pustaka Utama.
- [3] Wangge, E. S. (2014). PROFIL MUTU KOMODITI UNGGULAN PERKEBUNAN KABUPATEN ENDE (KOMODITI KEMIRI). *AGRICA*, 7(1), 23-33.
- [4] Hasan, I. (2015). Pengembangan Model Agribisnis Berorientasi Ekspor Bagi Koperasi, USAha Kecil Mikro Dan Menengah (Kumkm) Kabupaten Aceh Tengah-Provinsi Aceh. *Orasi Bisnis: Jurnal Ilmiah Administrasi Niaga*, 13(1).
- [5] Alfadjri, M. F., & WP, I. T. (2014). Analisis Teknis dan Ekonomis Pengembangan Galangan Repair Kapal Khusus LNG Ship.
- [6] Fadhillah, H. (2022). *Pengembangan E-Modul Fisika Dasar Berbasis Pendekatan Sainifik Pada Materi Gaya Konservatif, Energi Potensial Gravitasi, Gaya Sentripetal* (Doctoral Dissertation, Universitas Jambi).
- [7] Leni, D., Bahar, Z., & Selviyanty, V. (2018). Rancang bangun mesin perajang pelepah sawit untuk pakan ternak. *Jurnal Teknik Mesin*, 11(2), 51-57.
- [8] Ortiz-León, G. N., Loinard, L., Kounkel, M. A., Dzib, S. A., Mioduszewski, A. J., Rodríguez, L. F., ... & Gudehus, D. (2017). The Gould's Belt Distances Survey (GOBELINS). I. Trigonometric parallax distances and depth of the ophiuchus complex. *The Astrophysical Journal*, 834(2), 141.
- [9] Peruri, V. N. L. (2021). *Study of energy efficiency comparison between smooth V-belt and cogged V-belt for power transmission* (Doctoral dissertation, University of Missouri--Columbia).
- [10] Widyanugraha, A., Santosa, A., & Santoso, D. T. (2020). Perancangan Mesin Penggiling Padi dan Penepung Sekam Padi Skala Rumah Tangga. *Jurnal Teknik Mesin*, 13(2), 69-75.
- [11] Abdalaal, R. M., Ho, C. N. M., Leung, C. K., & Chung, H. S. H. (2019). A remotely central dimming system for a large-scale LED lighting network providing high quality voltage and current. *IEEE Transactions on Industry Applications*, 55(5), 5455-5465.
- [12] Agustina, D., Yulianti, D. A., & Wahyudi, I. (2020). Rancang Bangun dan Uji Coba Prototipe Mesin Pemecah Cangkang Buah Kemiri. *Jurnal Penelitian Pertanian Terapan*, 20(1), 45-52.
- [13] Siregar, H., Sari, P. S., & Piliang, Y. (2018). Pengaruh Kecepatan Putar Rotor Terhadap Kinerja Mesin Pemecah Cangkang Biji Kemiri. *Jurnal Teknologi Pertanian*, 19(2), 112-119.
- [14] Adriansyah, A., & Setiawan, A. (2017). Pengembangan Alat Pemecah Cangkang Biji Kemiri Berbasis Konsep Tumbukan. *Prosiding Seminar Nasional Teknik Mesin*, 6, 50-54.
- [15] Hutapea, D., & Tumanggor, A. (2015). Pemecahan Cangkang Biji Kemiri dengan Mesin Pemecah Tipe Roll Mill. *Jurnal Ilmu Teknik Industri*, 10(1), 10-17.
- [16] Anwar, A., & Marbun, D. P. (2014). Peningkatan Efisiensi Mesin Pemecah Cangkang Biji Kemiri Melalui Variasi Kecepatan Putaran Rotor. *Jurnal Ilmu Teknik Mesin*, 5(2), 78-85.